 Instructions for use and warranty for Cafissimo easy

## Contents

2	Intended use and location	9	Making a beverage
2	About these instructions	11	Adjusting the strength of the beverage (beverage quantity)
3	Safety warnings	12	Standby mode
5	At a glance	12	Cleaning
5	Control panel – button functions	13	Descaling
6	Initial operation – prior to first use	15	Problems / solutions
7	Rinsing the machine	16	Disposal
8	The finest aroma – the finest flavour	16	Technical specifications
8	Using large / small cups or glasses	17	Warranty

 We check every machine carefully and test them with coffee capsules and water. Despite thorough cleaning, it is possible for minimal residues of coffee and water to remain in the machine. This is not a sign of poor quality - the machine is in perfect working order.

## Intended use and location

The machine has been designed for the following uses:

- Brewing black coffee, caffè crema and espresso with Tchibo capsules.

It has been designed for use in households or for similar applications such as

- in shops, offices or similar work areas,
- in agricultural buildings,
- by customers in hotels, motels, bed and breakfast establishments or other places offering accommodation.

Set up the machine in a dry, indoor room. Avoid rooms with high humidity or high dust content. The machine is suitable for use at ambient temperatures of +10 to +40°C.

---

## About these instructions

Read the safety warnings carefully and only use the machine as described in these instructions to avoid accidental injury or damage. Keep these instructions for future reference.

If you pass the machine on to another person, remember to give them these instructions.

Symbols used in these instructions:



This symbol warns you of the danger of injury.



This symbol warns against the danger of injury caused by electricity.

Signal words:

**DANGER** warns you of potential severe injuries and danger to life.

**WARNING** warns you of injuries and severe material damage.

**CAUTION** warns you of minor injuries and damage.



This indicates additional information.

## Safety warnings



### **DANGER to children and people with a restricted capability of operating appliances**

- Children must not be allowed to play with the machine. Keep the machine and mains cable away from children under the age of 8.
- This machine can be used by children aged 8 and over or by people with reduced physical, sensory or mental capabilities, or who lack experience and/or knowledge, provided they are supervised or have been trained in the safe use of the machine and understand the potential dangers.
- Children must not be allowed to clean the machine unless they are over 8 years of age and supervised while doing so. This machine is maintenance-free.
- Set up the machine out of the reach of children.
- Keep the packaging material out of the reach of children. There is a risk of suffocation!

### **DANGER due to electricity**

- Never immerse the machine, mains plug or mains cable in water, as this could cause an electric shock. Never touch the mains plug with wet hands. Do not use the machine outdoors.
- Never leave the machine unattended while in use.

- Only connect the machine to a properly installed, earthed wall socket. The mains voltage must comply with the requirements stated in the machine's technical specifications.
- The mains cable must not be kinked or squeezed. Keep it away from sharp edges and sources of heat.
- Do not use the machine if the machine, mains cable or mains plug is damaged or if the machine has been dropped.
- Do not make any modifications to the machine, mains cable or other parts. Electrical appliances must only be repaired by qualified electricians, as improper repairs can cause considerable damage. Only have repairs carried out by a specialist workshop or our customer care service.
- If the mains cable of this machine becomes damaged, it must be replaced by the manufacturer, its customer service or by a similarly qualified person in order to avoid any hazards.
- Remove the mains plug from the wall socket ...
  - ... if a fault occurs,
  - ... if the machine will not be used for any length of time,
  - ... before cleaning the machine.Always pull on the mains plug, not the cable.
- To disconnect the machine from the power supply completely, remove the mains plug from the wall socket.

**WARNING - risk of fire**

- Set up the machine so that it is free-standing. It must not lean against a wall or be placed in a corner, in a cupboard, against a curtain or anything similar.

**WARNING - risk of scalds/burns**

- Do not touch the spout during or immediately after use. Avoid contact with beverages being dispensed from the spout.
- Do not raise the lever while the machine is being used. Keep the capsule opening closed and do not pull out the front drawer with the used capsule container.

**CAUTION - risk of injuries or material damage**

- **Use only original Tchibo Cafissimo capsules.** Do not use capsules from other manufacturers, nor damaged or deformed capsules, and never fill the machine with ground coffee or coffee beans, as this would damage the machine. In these cases, any repairs would not be covered by the warranty.
- Only use the machine with the front drawer and used capsule container inserted.
- Always pour fresh, cold tap/drinking water into the water tank. Do not use carbonated mineral water or any other liquids.
- Descale the machine as soon as it indicates that this is necessary.

- The capsule opening contains two capsule punchers. These punchers pierce both sides of the capsule when the lever is pressed down. Never reach into the capsule opening. Keep your fingers and any objects away from the capsule opening as you fold down the lever.
- Do not lift the machine up by the lever. To move the machine, hold it by the outer casing.
- Place the machine on a solid, level surface that is well illuminated and resistant to moisture and heat.
- To ensure that the casing does not melt, do not place the machine on a hob or directly next to a hot oven, radiator or anything similar.
- Route the mains cable in such a way that it cannot be tripped over. Do not let the mains cable hang down from the surface the machine is put on. Otherwise, there is a risk of the machine being pulled down.
- The machine is equipped with non-slip feet. Work surfaces often have varnished or plastic finishes and are treated with a variety of care products. Some of these may contain substances that react adversely to the non-slip feet and soften them. If necessary, place a non-slip mat under the machine.
- The machine must not be exposed to temperatures below 4 °C. Residual water in the heating system could freeze and cause damage.

## At a glance

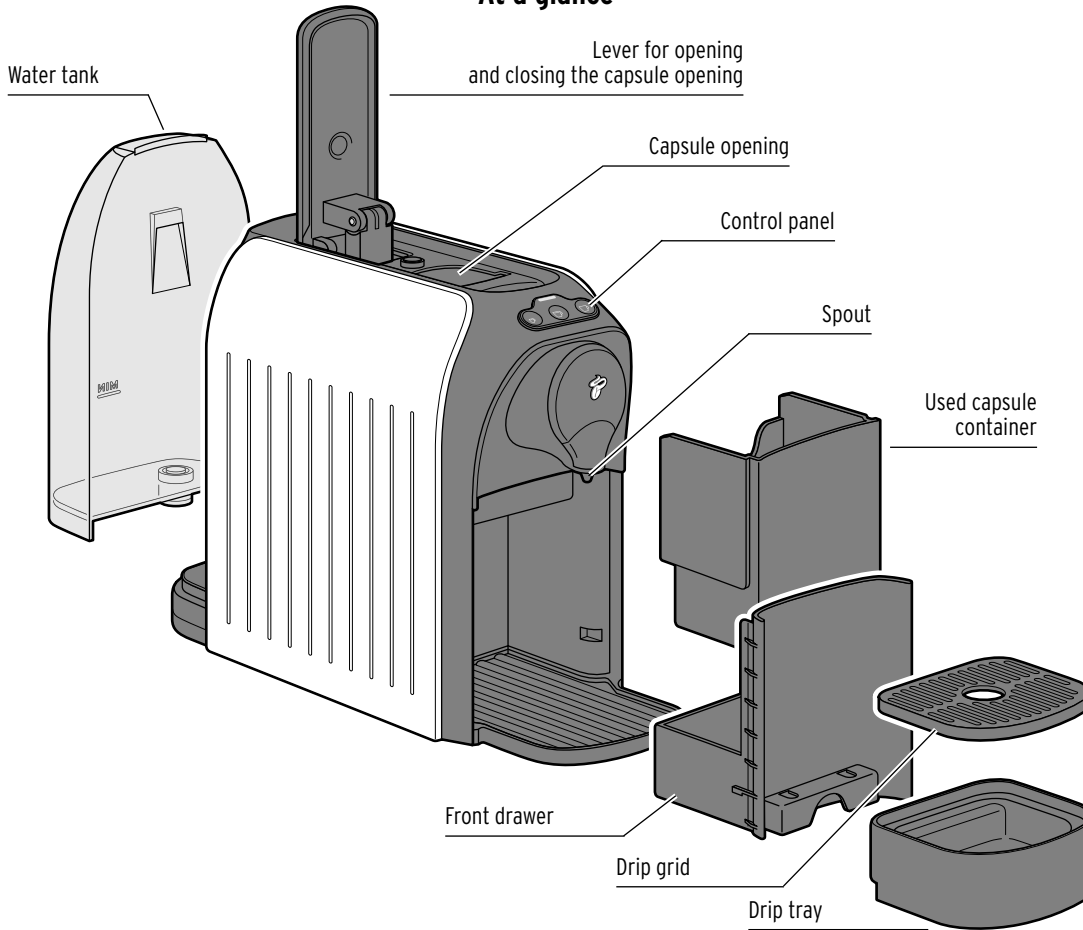

## Control panel – button functions

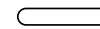

Indicator light

- **Flashes red**  
(water container empty)
- **Lights up yellow** (machine  
needs to be descaled)



• **Make espresso**



• **Make caffè crema**



• **Make black coffee**

## Initial operation – prior to first use

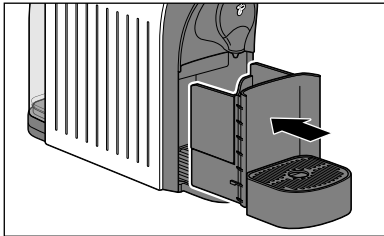

1. Make sure that the used capsule container is correctly inserted into the front drawer. The front drawer needs to be pushed in all the way and the drip tray correctly inserted.

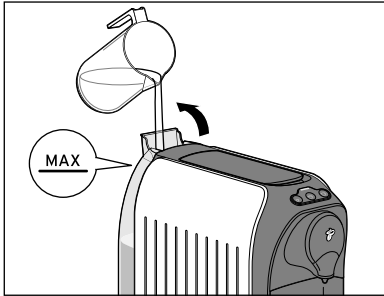

2. Fill the water tank up to the **MAX** mark with fresh, cold tap/drinking water.
  - Open the flap in the top of the water tank and pour in the water through the filling inlet, or ...

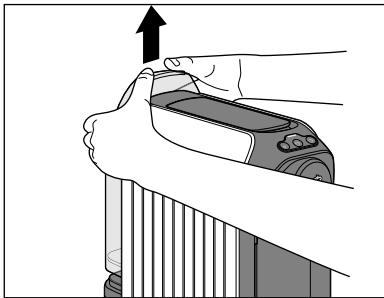

- ... pull the water tank straight up and out of the machine and then fill it with water.
- When you reinsert the water tank into the machine, push it down as far as it will go.

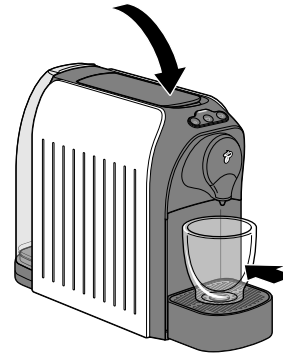

3. The lever must be folded down. Fold it down if necessary.
4. Place an empty cup underneath the spout.

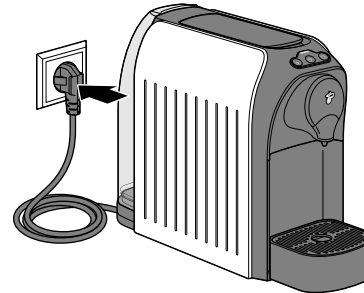

5. Connect the mains plug to an easily accessible wall socket.

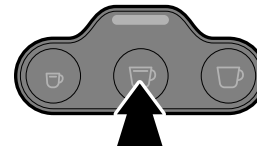

6. Press one of the 3 beverage buttons to switch on the machine. You will hear a brief beeping sound.

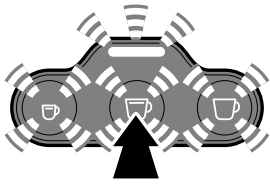

The indicator light flashes yellow and the 3 beverage buttons flash white.

- Press the middle button (caffè crema).  
The pump starts to operate. As soon as the pipes are filled with water, the pump stops automatically. A small quantity of water runs into the cup underneath the spout. You will then hear 2 beeps.



Only the 3 beverage buttons will continue to flash; the machine is heating up to brew coffee.



As soon as the machine has heated up, you will hear a beeping sound. The 3 beverage buttons will remain permanently lit.

- Pour away the water in the cup and rinse the machine twice as described in the "Rinsing the machine" section. The machine is then ready for use.

## Rinsing the machine

After switching the machine on for the first time, or if you have not used the machine for longer than 2 days, rinse the machine by allowing 2 cups of water to flow through it (without a capsule).

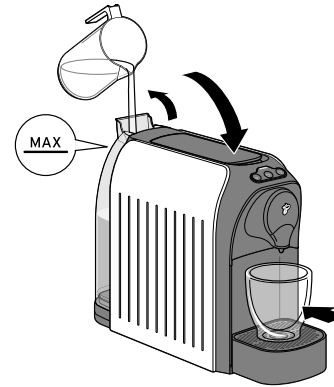

- Fill the water tank up to the **MAX** mark with fresh, cold tap/drinking water.
- Fold down the lever if necessary.
- Place an empty cup underneath the beverage spout.

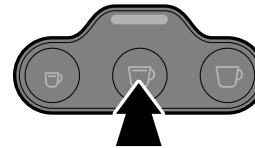

- If necessary, press one of the 3 beverage buttons to switch on the machine. You will hear a short beeping sound.

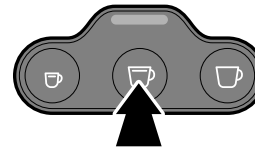

- Once all 3 beverage buttons are permanently lit, press the middle button (caffè crema). The pump will flush water through the pipes, which will then run into the cup underneath. The machine will beep once the rinsing process has finished.

6. Pour the water away.

7. Repeat steps 3 to 6.

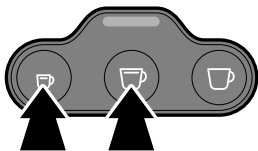

8. **To switch the machine off**, press the left button (espresso) and the middle button (caffè crema) briefly at the same time.

9. Finally, empty the front drawer and, if necessary, the used capsule container:

- ▷ Lift off the drip tray (a).
- ▷ Pull out the front drawer as illustrated (b).

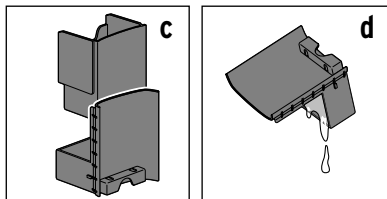
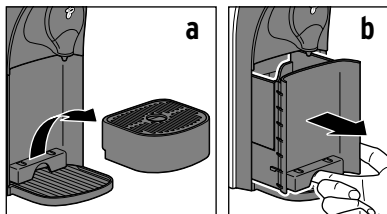

- ▷ Remove the used capsule container (c).
- ▷ Empty the front drawer and, if necessary, the used capsule container (d).

10. Reinsert all parts into the machine.

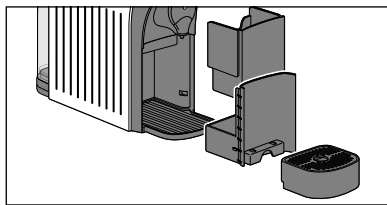

## The finest aroma – the finest flavour

### One capsule per cup

Each capsule is a single portion for one cup of black coffee, caffè crema or espresso.

### Full aroma

Only insert a capsule when you intend to use the machine. The capsule is pierced as it is inserted. If it is not used immediately, the aroma will fade.

### Preheating the cup

Fill the cup with hot water and then pour it away shortly before using the cup. This helps your cup of coffee taste its best.

### Beverage strength

Adjust the strength of the coffee to suit your personal taste by changing the quantity of water. This is very easy to do, and is described in the "Adjusting the strength of the beverage (beverage quantity)" section.

## Using large / small cups or glasses

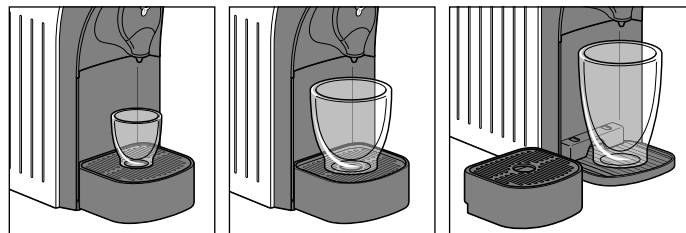

Leave the drip tray in for espresso and "normal" cups of coffee.

Remove the drip tray for tall glasses.



## Making a beverage

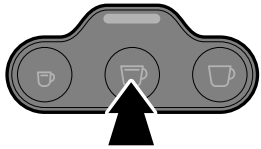

1. Press one of the 3 beverage buttons to switch on the machine.  
You will hear a short beeping sound.



The 3 beverage buttons flash while the machine is heating up to make a beverage.



As soon as the machine has heated up, you will hear a beeping sound. The 3 beverage buttons will remain permanently lit.

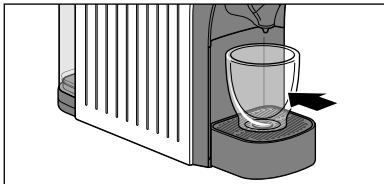

2. Place an empty cup underneath the spout.

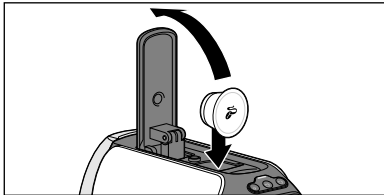

3. Fold back the lever as far as it will go and insert a capsule as illustrated with the lid facing forwards.



The capsule must be intact: Do not pierce it and do not remove the capsule lid or insert a deformed capsule!

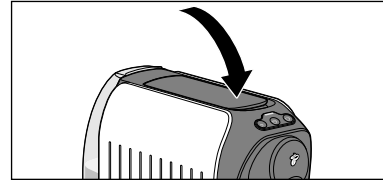

4. Fold the lever down completely. This pierces the base and lid of the inserted capsule.

5. Press the beverage button that corresponds to the capsule you have inserted:

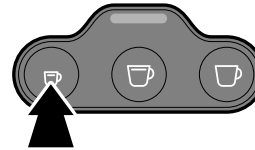

**Espresso**

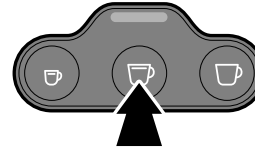

**Caffè crema or**

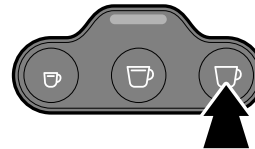

**Black coffee.**

The brewing process starts and stops automatically. You will hear a beeping sound as soon as the machine has finished brewing coffee.

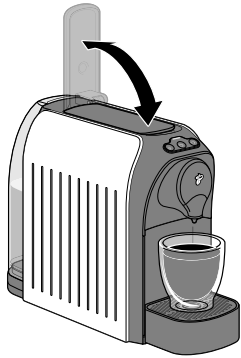

6. Before removing the coffee cup from the drip grid, fold back the lever as far as it will go.

The machine loses pressure. Some liquid may leak out when this happens. The used capsule then falls into the used capsule container.

**i** As is the case with professional espresso machines, a small amount of espresso or caffè crema is pre-brewed for espresso and caffè crema capsules. This enhances the aroma. This process can be identified by the short pause at the beginning of the brewing process. Black coffee is made without a pre-brewing process, just like with standard filter coffee machines.

▷ If you would like to stop the brewing process prematurely, press the same beverage button again while brewing.

**Tip:** You can adjust the strength of the beverage by altering the amount of water. Refer to the "Adjusting the strength of the beverage (beverage quantity)" section for information on how to do this.

Default settings (amounts are approximate):

**Espresso** approx. 40 ml | **Caffè crema** approx. 125 ml | **Black coffee** approx. 125 ml

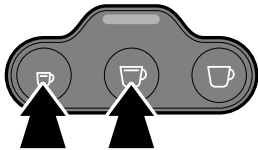

7. **To switch the machine off**, press the left button (espresso) and the middle button (caffè crema) briefly at the same time.

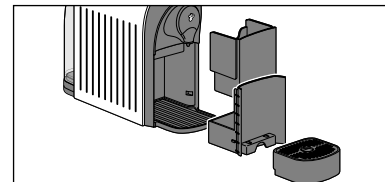
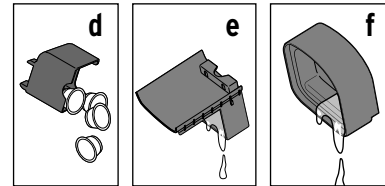
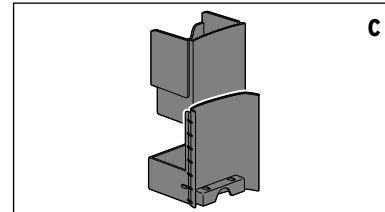
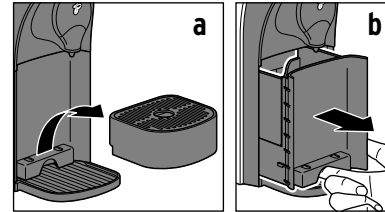

8. Finally, empty the front drawer, the used capsule container and the drip tray if necessary:

▷ Lift off the drip tray (a).  
▷ Pull out the front drawer as illustrated (b).

▷ Remove the used capsule container (c). The used capsule container must be emptied once a day or when it is full. Approx. 4 capsules fit inside.

▷ Empty the used capsule container (d).  
▷ Empty the front drawer (e).  
▷ Empty the drip tray if necessary (f).

9. Reinsert all parts into the machine.

## Adjusting the strength of the beverage (beverage quantity)

Adjust the strength of the beverage to suit your personal taste by altering the quantity of water. You can do this for one single brewing procedure or save the setting.

### Adjusting the strength for the current brewing procedure (without saving the setting)

- ▷ If the beverage is **too weak** for your taste, you can stop the water flow prematurely by pressing the flashing beverage button.
- ▷ If the beverage is **too strong** for your taste, start the brewing procedure again without inserting a new capsule. Press the button again as soon as sufficient water has run through.

Default settings (amounts are approximate):

**Espresso** approx. 40 ml | **Caffè crema** approx. 125 ml | **Black coffee** approx. 125 ml

The water quantity can be set between approx. 30 and 250 ml.

### Setting the strength permanently (saving the setting)

You can change the factory settings for the water quantity permanently. This enables you to make your favourite beverage every time, exactly the way you like it. You can customise the setting for each type of coffee: for espresso, caffè crema and black coffee.

1. Proceed in the same way as described in the “Making a beverage” section: Fill the water tank, insert a capsule and place a cup underneath the spout.
2. Press and hold the relevant beverage button (the indicator light will turn yellow) until the required beverage quantity has been dispensed into the cup. When you release the button, the machine will save that quantity. The machine will beep and the yellow indicator light will disappear as confirmation.

If the settings are not to your taste, simply repeat the procedure to change them again.

## Restoring the factory settings

To reset to the original beverage amounts, proceed as follows:

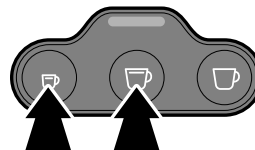

1. Switch the machine off if necessary: To do this, press the left button (espresso) and the middle button (caffè crema) briefly at the same time.

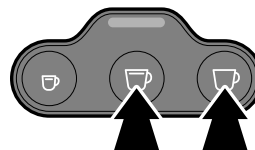

2. Then press and keep holding down the middle button (caffè crema) and the right-hand button (black coffee).

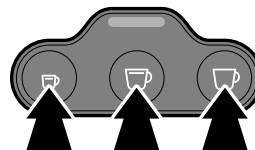

3. In addition, press the left button (espresso) once briefly until you hear a beeping sound as confirmation and the 3 beverage buttons flash.

4. Now let go of the middle and right-hand buttons.

The factory settings for the water quantities have been restored.

## Standby mode

If no button has been pressed for about 9 minutes, the machine will automatically switch to standby mode. The 3 beverage buttons will go out. The machine will then use very little electricity. This is both a safety function and a way to save energy. However, you should always switch the machine off manually after use:

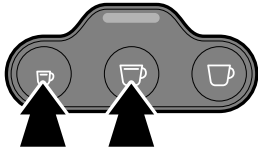

- ▷ To switch the machine off, press the left button (espresso) and the middle button (caffè crema) briefly at the same time.

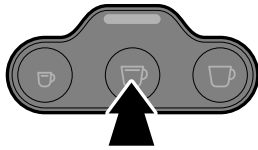

- ▷ Press one of the 3 beverage buttons to switch the machine on again. You will hear a short beeping sound.



To disconnect the machine from the power supply completely, remove the mains plug from the wall socket.

## Cleaning



### **DANGER** - risk of fatal electric shock

- Switch off the machine and remove the mains plug from the wall socket before cleaning the machine.
- Never immerse the machine, mains plug or mains cable in water or any other liquids.
- Do not clean the machine with a water jet. Clean it only as described in the following instructions.

### **CAUTION** - material damage

Do not use any caustic, aggressive or abrasive products for cleaning.

### **Cleaning the casing**

- ▷ Wipe the casing with a soft, damp cloth.
- ▷ Wipe the compartment for the used capsule container with a soft, damp cloth as required.

### **Rinsing the water tank daily**

- ▷ Rinse out the water tank daily under running water. This prevents limescale deposits or other particles from clogging the opening on the bottom of the water tank.

### **Thoroughly cleaning the water tank weekly**

The water tank should be cleaned thoroughly once a week.

- ▷ Wash the water tank in warm water with washing-up liquid. Rinse it out thoroughly under running water and then dry it.  
The tank is not dishwasher-safe.

### **Cleaning the used capsule container and drip tray/grid**

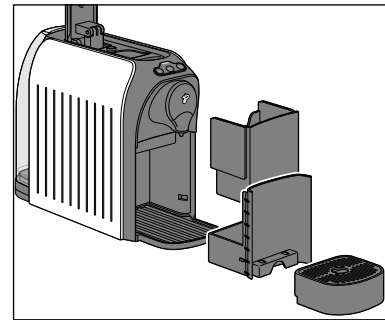

1. Lift off the drip tray.
2. Remove the drip grid from the drip tray and empty the drip tray.
3. Pull out the front drawer and remove the used capsule container.
4. Empty the used capsule container.

- Wash all parts using a washing-up liquid. Dry the parts thoroughly. The drip tray, drip grid, front drawer and used capsule container can also be cleaned in the dishwasher.
- Then reinsert all parts into the machine.

## Descaling



If the indicator light is yellow, the machine needs to be descaled. Do this within the next couple of days. Do not wait any longer, otherwise so much limescale may collect that a descaling agent will no longer have any effect.  
**Descaling takes approx. 30 minutes.**

**CAUTION** – damage to the machine due to limescale deposits

- **Descale the machine as soon as it indicates that this is necessary (after approx. 50 litres).** This increases its service life and saves energy.
- Do not use any descaling agents made on the basis of formic acid.
- Use a standard liquid descaling agent suitable for coffee and espresso machines. Other agents may damage materials in the machine and/or have no effect.

**Tip:** We recommend durgol® swiss espresso®, which is available from any Tchibo branch and from specialist retailers.

To descale the machine, proceed as follows:

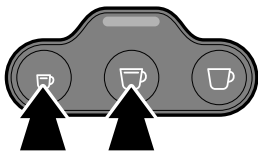

- Switch the machine off if necessary: To do this, press the left button (espresso) and the middle button (caffè crema) at the same time.

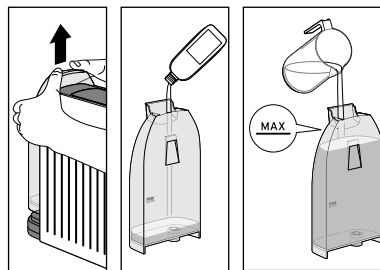

- Pour in a descaling agent:
    - ▷ Remove the water tank from the machine and pour one portion (125 ml) of durgol® swiss espresso® into the empty water tank. **IMPORTANT:** Pour in water **up to the MAX mark** and reinsert the container.
  - If you are using a different descaling agent, read the manufacturer's instructions. **IMPORTANT:** Pour in the descaling solution **up to the MAX mark** and reinsert the container into the machine.

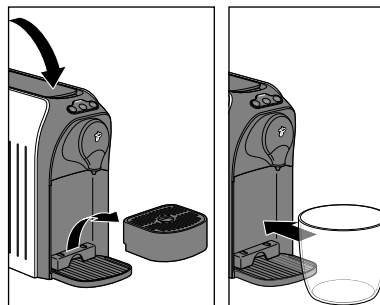

3. Fold down the lever and remove the drip tray if necessary.
    4. Place a container with a capacity of at least 600 ml under the spout.

**i** You will need to empty this container several times during the descaling process.

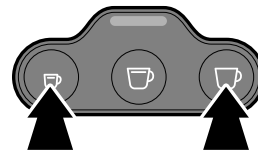

5. Press and hold the left button (espresso) and the right-hand button (black coffee) at the same time for approx. 5 seconds.

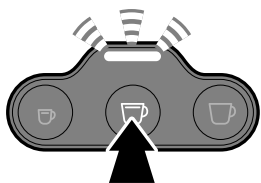

6. The middle beverage button will light up and the indicator light will flash alternately between red/yellow. Press the middle beverage button to start descaling.



The descaling procedure begins. The middle beverage button will go out and the indicator light will flash alternately between red/yellow. **The procedure takes approx. 25 minutes.**

The machine pumps descaling solution into the pipes several times in 2.5-minute intervals. About 60 ml is dispensed into the container below every time.

7. Do not leave the machine unattended during the descaling process. Make sure you pour out the water in the container underneath in time to prevent the container from overflowing.



As soon as all of the descaling solution has been pumped through the machine, **the machine stops for approx. 2.5 minutes.**

The indicator light will continue to flash alternately between red/yellow.

After 2.5 minutes, the middle beverage button will light up again and you will hear a beeping sound.

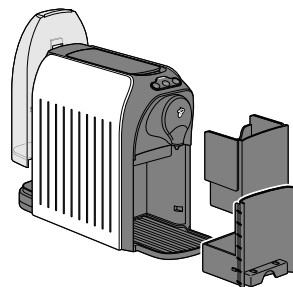

8. Remove the water tank, the front drawer and the used capsule container from the machine.
9. Wash all parts using a washing-up liquid. Dry all parts thoroughly.
10. Then reinsert all parts into the machine.

### Rinsing phase

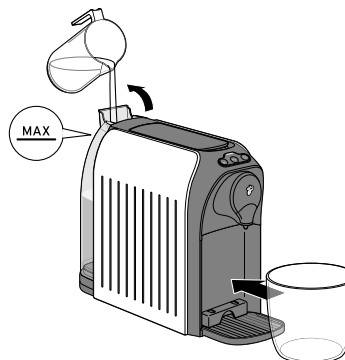

11. For the rinsing phase, fill the water tank **up to the MAX mark** with cold tap water.
12. Place an empty container with a capacity of at least 600 ml under the spout.

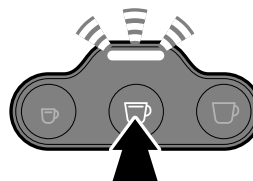

13. Press the middle beverage button to start rinsing.



The rinsing phase will begin. The middle beverage button will go out and the indicator light will flash yellow. **The procedure takes approx. 2 minutes.**

14. Approx. 600 ml of water will be rinsed through the system. Keep an eye on the container and empty it before it overflows.
15. The machine automatically switches to standby once it is finished. The indicator light goes out. The descaling process is complete.

---

## Problems / solutions

---

<p>The indicator light is flashing red and there are several beeping sounds.</p>	<p><b>Is the water tank empty?</b></p> <ul style="list-style-type: none"> <li>▷ Fill the water tank with fresh water.</li> <li>▷ Press one of the beverage buttons. The pump starts to operate. As soon as the pipes are filled with water, the pump stops automatically. When the beverage buttons remain permanently lit, the machine is ready for use again.</li> </ul>
--	--

<p>There are coffee grounds in the cup.</p>	<p>A small residue of coffee grounds always remains at the bottom of the cup. This is a feature of the system and is not a fault.</p>
---	---

<p>The beverage is not hot enough.</p>	<p>Especially in the case of espresso, the quantity is so small compared to the size of the cup that it cools down quickly. Preheat the cup by filling it with hot water and pouring it away shortly before using the cup.</p>
--	--

<p>Water is dripping out of the spout.</p>	<p>The water in the system expands as the machine heats up and, as a result, a little water drips out of the spout.</p>
--	---

---

<p>The indicator light stays yellow.</p>	<p>The machine needs to be descaled. Do this within the next couple of days. Do not wait any longer, otherwise so much limescale may collect that a descaling agent will no longer have any effect. A self-induced defect of this kind will not be covered by the warranty. Proceed as described in the "Descaling" section.</p>
--	--

<p>It is not possible to press down the lever.</p>	<p>Check whether the used capsule container is full. Empty it if necessary.</p> <p>If a capsule is trapped in the capsule opening, fold the lever back completely and press the capsule through from the top to the bottom. Do not reinsert a capsule if it is deformed!</p>
--	--

<p>The rinsing phase does not finish; the water tank is empty, the indicator light is flashing red and the machine is beeping.</p>	<p>Fill the water tank with cold tap water <b>up to the MAX mark</b> and reinsert the tank into the machine. Continue with step 12 in the chapter "Descaling", section "Rinsing phase".</p>
--	---

---

## Disposal

The product and its packaging have been manufactured from valuable materials that can be recycled. Recycling reduces the amount of refuse and helps to preserve the environment.

Dispose of the **packaging** in the proper manner. Make use of the local facilities provided for collecting paper, cardboard and lightweight packaging.



**Appliances** marked with this symbol must not be disposed of along with household waste!

 You are legally bound to dispose of old appliances separately from household waste. Information about where old appliances can be disposed of free of charge is available from your local authorities.

## Technical specifications

Type / Model:	Cafissimo 370 635
Product number:	see "Warranty" section
Mains voltage:	220–240 V ~ 50 Hz
Power:	1250 watts
Power consumption when turned off:	<0.5 watts
Automatic switch-off:	approx. 9 minutes
Protection class:	I
Pump pressure:	max. 15 bar
Sound pressure level:	<70dB(A)
Ambient temperature:	+10 to +40°C
Preset brew quantities:	Black coffee approx. 125 ml Caffè crema approx. 125 ml Espresso approx. 40 ml
Made exclusively for:	Tchibo GmbH, Überseering 18, 22297 Hamburg, Germany





## Warranty

We grant a **24-month warranty** from the date of purchase.

Tchibo GmbH, Überseering 18, 22297 Hamburg, Germany

We will remedy all defects in workmanship or materials within the warranty period. In order for the warranty to be granted, all warranty claims must be accompanied by proof of purchase from Tchibo or from an authorised Tchibo distribution partner. This warranty is only valid within the EU, Switzerland and Turkey.

If, contrary to our expectations, a defect is found, please contact our customer care service at the following e-mail address:

**service@tchibo.de**

Our customer consultants will be pleased to advise you on further procedure.

Damage due to improper use, failure to decalcify as well as worn parts and consumables, are not covered by the warranty.

Please have the product number at hand in case of any queries.

This warranty does not restrict statutory warranty rights.

## Product number

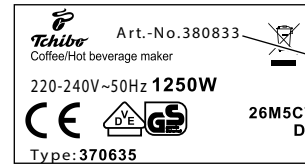

Product number

You can find your Cafissimo machine's product number on the type plate on the bottom of the casing. Before laying the Cafissimo on its side, remove the water

tank, the drip tray and front drawer with used capsule container. Lay a cloth or mat underneath the machine to protect the surface from remaining liquid/water that may leak out.